



REVISED ANALYSIS METHODOLOGY AND ASSUMPTIONS MEMORANDUM

Date: December 28, 2018 Project #: 22254.0

To: Larry Lewis and Kerry Kemp, City of Waldport
David Helton, Oregon Department of Transportation

From: Matt Bell and Susan Wright, Kittelson & Associates, Inc.

Project: Waldport Transportation System Plan (TSP) Update

Subject: Revised Analysis Methodology and Assumptions Memo (Subtask 2.3)

INTRODUCTION

This memorandum documents the methodology and assumptions associated with the existing and future transportation system operations analyses for the City of Waldport Transportation System Plan (TSP) Update. The methodology and assumptions included in this memorandum are based on guidance provided in the Oregon Department of Transportation (ODOT) Transportation System Plan Guidelines (Reference 1), the ODOT Analysis Procedures Manual (APM – Reference 2), and direction provided by City and ODOT staff. The analyses described in this memorandum will help identify potential deficiencies in the transportation system, including:

- » Traffic operations at the study intersections under existing and future traffic conditions,
- » Traffic safety at the study intersections and along study area roadways,
- » Gaps and deficiencies in the bicycle and pedestrian network,
- » Gaps and deficiencies in the transit service (service frequency, hours, coverage, etc.), and
- » Gaps and deficiencies in other travel modes.

This information will serve as a baseline for identifying a comprehensive list of needs and deficiencies to be addressed as part of the TSP update. It will also serve as a baseline for identifying and evaluating potential solutions and developing a prioritized list of improvements for the TSP update.

STUDY INTERSECTIONS

The study intersections for the Waldport TSP Update were determined by the City and ODOT prior to the development of the scope of work. There are a total of nine study intersections located along City and ODOT facilities, including one signalized and eight unsignalized intersections. Figure 1 illustrates the location of the study intersections.

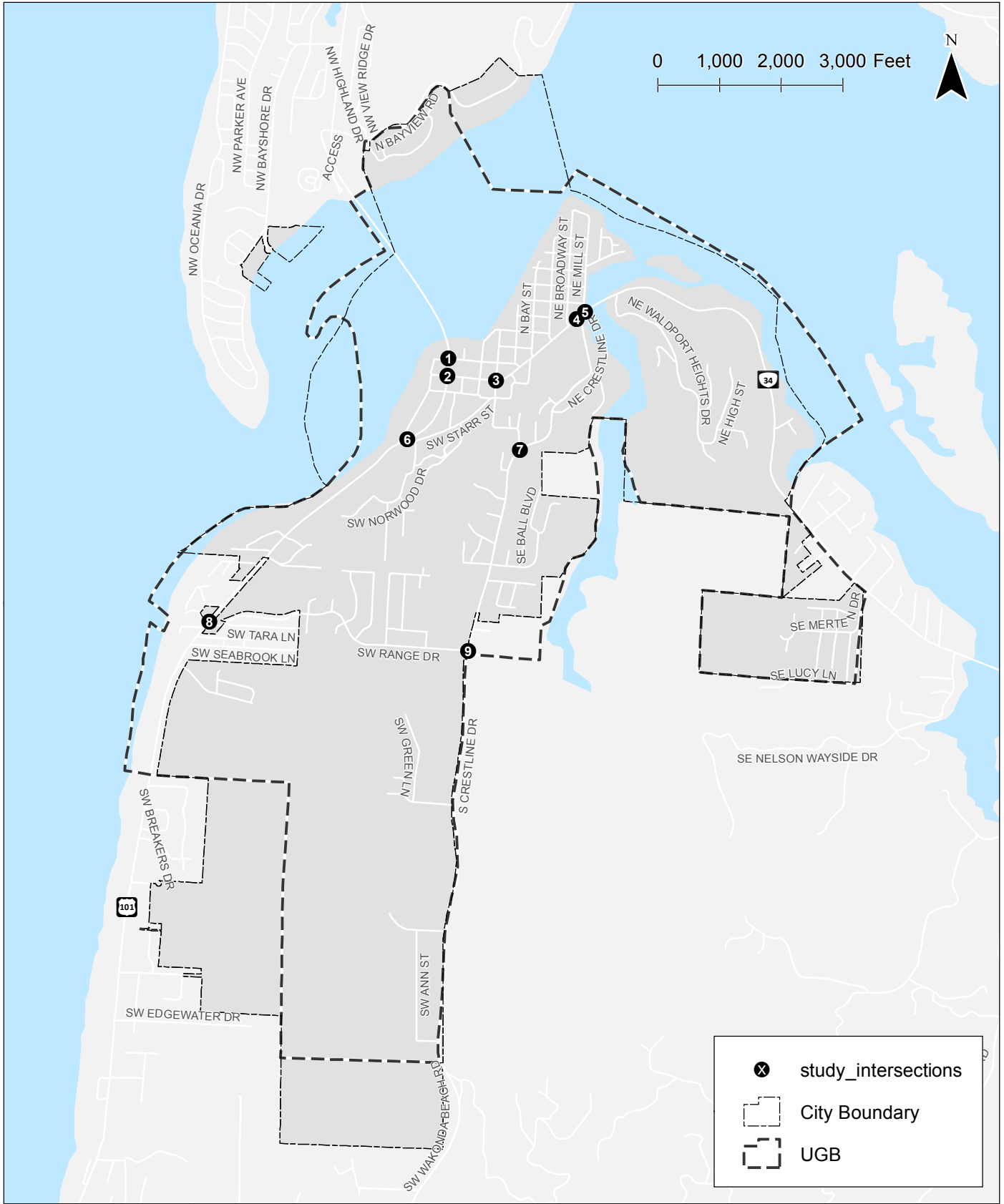

**Study Intersections
Waldport, Oregon**

**Figure
1**

H:\22122254 - Waldport TSP Update\gis\Method1_Study Intersections.mxd - mbell - 11:46 AM 12/27/2018



WALDPORT, OREGON TRANSPORTATION SYSTEM PLAN UPDATE

The following provides information related to the traffic counts conducted at the study intersections and how they will be used to develop existing and future traffic volumes. The 9 study intersections include:

STATE FACILITIES

1. Oregon Coast Highway No. 9 (US 101)/NE Spring Street
2. US 101/Asea Highway No. 27 (OR 34)
3. US 101/SW Starr Street
4. US 101 SW Range Drive
5. OR 34/NW Cedar Street
6. OR 34/NE Crestline Drive
7. OR 34/NE Mill Street

CITY FACILITIES

8. SW Cedar Street/S. Crestline Drive
9. SW Range Drive/S. Crestline Drive

TRAFFIC COUNTS

Manual turning movement counts were conducted at the study intersections in September 2018 and October 2018 while school was in session. All the counts were conducted on a typical mid-week day over a four-hour period (2:00 to 6:00 p.m.) peak period, with the exception of the US 101/OR 34 counts which were conducted over a 16-hour period (6:00 a.m. to 10:00 p.m.). All the counts include the total number of pedestrians, bicyclists, and motor vehicles that entered the study intersections in 15-minute intervals. *The traffic count worksheets are provided in Attachment A.*

PEAK HOUR DEVELOPMENT

The traffic counts were reviewed to determine if individual intersection peaks or a system-wide peak hour should be used as a basis for the operational analyses. Based on the review, the individual intersection peaks tend to vary between facilities (e.g. US 101, OR 34, Crestline Drive); however, the percent difference in total entering volumes (TEV) between the individual intersection peaks and the system-wide peak hour are minimal. Therefore, a system-wide peak hour was selected for the analysis. The system-wide peak hour for the study intersections was identified as 4:15 to 5:15 p.m. Table 1 summarizes the study intersections, the individual intersection peak hours, the TEV during the individual intersection peaks, the TEV during the system-wide peak hour, and the percent difference in TEV between the individual intersection peaks and the system-wide peak hour.



WALDPART, OREGON TRANSPORTATION SYSTEM PLAN UPDATE

Table 1: Study Intersection Peak Hours

Map ID	Intersection	Intersection Peak Hour	Intersection Peak TEV	System-Wide Peak TEV	% Difference
1	US 101/NE Spring Street	4:15PM – 5:15 PM	969	969	0%
2	US 101/OR 34	4:15PM – 5:15 PM	1,209	1,209	0%
3	US 101/SW Starr Street	4:15PM – 5:15 PM	821	821	0%
4	US 101/ SW Range Drive	4:15PM – 5:15 PM	769	769	0%
5	OR 34/NW Cedar Street	4:30PM – 5:30 PM	673	665	1.2%
6	OR 34/NE Crestline Drive	4:45PM – 5:45 PM	455	432	5.3%
7	OR 34/NE Mill Street	4:45PM – 5:45 PM	433	416	4.1%
8	SW Cedar Street/S. Crestline Drive	4:00PM – 5:00 PM	220	198	11.1%
9	SW Range Drive/S. Crestline Drive	5:00PM – 6:00 PM	319	293	8.9%

SEASONAL FACTORS

30th Hour Volumes (30 HV) for the Waldport TSP Update will be developed based on the traffic counts collected at the study intersections and the application of seasonal adjustment factors consistent with the methodology identified in the APM. The APM identifies three methods for identifying seasonal adjustment factors for highway traffic volumes. All three methods utilize information provided by Automatic Traffic Recorders (ATRs) located in select locations throughout the State Highway System that collect traffic data 24-hours a day, 365 days a year. Each method was evaluated to determine the most appropriate method for the study intersections. Based on the evaluations, the Seasonal Trend Table method will be used to develop 30 HV volumes at the ODOT study intersections. The results of the evaluation are summarized below.

On-Site ATR

No ATRs are located within or near the project area.

ATR Characteristics Table

The ATR Characteristics Table Method requires that the ATR be located on a facility that shares similar characteristics with the facility to be adjusted, such as seasonal traffic trends, area type, and number of travel lanes. The ATR Characteristic Table Method also requires that the Average Annual Daily Traffic (AADT) at the ATR is within 10 percent of the AADT near the project area. Based on a review of the ATR Characteristics Table and AADTs within the study area, no ATRs were identified that share similar characteristics with US 101 or OR 34 within Waldport. All ATRs located along facilities classified as either Coastal Destination or Coastal Destination Routes in small urban settings did not have similar physical characteristics or were not within 10 percent of the AADT in the project area.

Seasonal Trend Table

The seasonal trend table method is used when there is not an ATR nearby or in a representative area. The APM notes that in certain areas, averaging seasonal trends may yield a more appropriate factor than just a single trend.



WALDPOR, OREGON TRANSPORTATION SYSTEM PLAN UPDATE

Specifically, Warrenton, Depoe Bay, and Yachats are identified for an average of the Coastal Destination and Coastal Destination Route Trends as Coastal Destination may be too high and Coastal Destination Route may be too low. Waldport shares similar characteristics to these cities and therefore was evaluated using an average of these trends. Traffic counts at the US 101/OR 34 intersection were taken on October 8th, 2018 while all other counts were taken on September 12th, 2018. A review of the existing traffic counts showed volumes between US 101/OR 34 and adjacent intersections balanced reasonably despite the different traffic count dates. Therefore, traffic counts along US 101 and OR 34 will be adjusted using the September 12th date. Table 2 summarizes the seasonal adjustment factor information, adjusted to the traffic count collection date of September 12th, 2018.

Table 2: Seasonal Adjustment Factor

Trend	September 1 Data	September 15 Data	Interpolated September 12	Peak Period Factor	Seasonal Adjustment Factor
Coastal Destination	0.8775	0.9257	0.9128	0.8293	1.1007
Coastal Destination Route	0.8301	0.9045	0.8847	0.7556	1.1708
				Average	1.1358

Source: Seasonal Trend Table Updated 8/1/2018, pulled 10/22/2018.

Based on the data shown in Table 2, traffic volumes along US 101 and OR 34 will be seasonally adjusted by a factor of 1.1358 to reflect 30 HV.

HISTORICAL FACTORS

All traffic counts were conducted in 2018; therefore, no historical factors are needed to adjust traffic volumes.

INTERSECTION OPERATIONAL STANDARDS

ODOT Facilities

ODOT uses volume-to-capacity (V/C) ratios to assess intersection operations. Table 6 of the *Oregon Highway Plan* (OHP – Reference 3) and Table 10-2 of the *Oregon Highway Design Manual* (HDM – Reference 4) provide maximum volume-to-capacity ratios for all signalized and unsignalized intersections located outside the Portland metropolitan area. The OHP ratios are used to evaluate existing and future no-build conditions, while the HDM ratios are used in the creation of future TSP alternatives which involve projects along state highways. The ODOT controlled intersections within the study area are located along US 101 and OR 34. Table 3 summarizes the v/c ratios that will be used to identify the existing and potential future operational issues at the ODOT study intersections.



WALDPORT, OREGON TRANSPORTATION SYSTEM PLAN UPDATE

Table 3: ODOT Mobility Standards

Map ID	Intersection	Traffic Control	OHP Mobility Target (major/minor)	HDM Standard (major/minor)
1	US 101/NE Spring Street	TWSC	0.90/0.95	0.75/0.80
2	US 101/OR 34 ¹	Signalized	0.95/0.95	0.90/0.90
3	US 101/SW Starr Street ¹	TWSC	0.95/1.0	0.90/0.95
4	US 101 SW Range Drive	TWSC	0.80/0.90	0.70/0.75
5	OR 34/NW Cedar Street ¹	TWSC	1.0/1.0	0.95/0.95
6	OR 34/NE Crestline Drive	TWSC	0.95/0.95	0.80/0.80
7	OR 34/NE Mill Street	TWSC	0.95/0.95	0.80/0.80

1. The segments of US 101 from OR 34 to SW Maple Street and OR 34 from US 101 to NW Cedar Street are designated as a Special Transportation Area (STA), which allows a high level of congestion, and therefore, has a higher mobility target.

City Facilities

The City of Waldport's 1999 TSP notes that "The City of Waldport does not have specific LOS standards for intersection operations. Typically, local jurisdictions in Oregon consider LOS E or better to be the standard for unsignalized intersections. At signalized intersections, LOS D or better is a typical standard for acceptable operations." Table 4 summarizes the LOS standards that will be used to identify existing and potential future operational issues at the City study intersection.

Table 4: City Mobility Standards

Map ID	Intersection	Traffic Control	Mobility Standard
8	SW Cedar Street/S. Crestline Drive	TWSC	LOS E
9	SW Range Drive/S. Crestline Drive	TWSC	LOS E

Traffic operations at the study intersections will be evaluated based on the mobility targets and standards shown in Tables 3 and 4. Potential solutions will be identified and evaluated for the study intersections that are found to exceed the mobility targets and standards under existing and/or future traffic conditions.

ANALYSIS MODEL PARAMETERS

The bullets below identify the specific sources of data and methodologies proposed to conduct the operational analyses. Analyses of all state facilities will be conducted according to the APM, unless otherwise agreed upon by the City and ODOT.

1. *Intersection/Roadway Geometry* (lane numbers and arrangements, cross-section elements, signal phasing, etc.) will be collected through aerial photography and confirmed through a site visit. Available



WALDPORT, OREGON TRANSPORTATION SYSTEM PLAN UPDATE

as-built data may also be used to verify existing roadway geometry. The analysis models will be built on scaled roadway line work from GIS or aerial photography.

2. *Operational Data* (such as posted speeds, intersection control, parking, transit stops, rail crossings, right-turn on red, etc.) will be collected through a site visit. Data will be reviewed and supplemented by available GIS data, traffic count DVDs, aerials, and photos.
3. *Peak Hour Factors (PHF)* will be calculated for each intersection and applied to the existing conditions analyses. Per the APM, PHFs of 0.95 will be used for the year 2040 analysis for high-order facilities (arterials), with 0.90 applied to medium-order facilities (collectors) and 0.85 applied to local roads. If the existing PHF is greater than these default future values, the existing PHF will be applied.
4. *Traffic Volume Development* for the study intersections will use the Zonal Cumulative Analysis methodology described in the APM. This methodology is suggested when analyzing entire cities of up to 10,000 residents. This type of analysis combines growth in regional traffic volumes with growth in local traffic volumes associated with projected household and employment growth within the city. The traffic volume projection process includes the three major modeling steps (trip generation, trip distribution, and trip assignment). The process accounts for the following four categories of vehicle trips:
 - a. *External-External (through trips)*: vehicles with an origin and destination outside the UGB. An example of an external-external trip is someone traveling from Newport to Yachats through Waldport.
 - b. *External-Internal (inbound trips)*: vehicles with an origin outside the city limits and a destination inside the UGB. An example of an external-internal trip is someone who works in Newport but returns home to Waldport during the evening peak hour.
 - c. *Internal-External (outbound trips)*: vehicles with an origin inside the city limits and a destination outside the UGB. An example of an internal-external trip is someone who works in Waldport but returns home to Yachats during the evening peak hour.
 - d. *Internal-Internal (local trips)*: vehicles with an origin and destination inside the UGB. An example of an internal-internal trip is someone who travels from their home to the grocery store without leaving the city.

Using these vehicle trip types, the basic steps for a zonal cumulative analysis are:

- a. Identify the study area and divide into transportation analysis zones (TAZ)
- b. Identify vacant lands, in-process developments, comprehensive plan allowed land uses/densities, and development rates using 2010 Census data, 2016 American Community Survey data, and GIS data to be provided by the City.
- c. Estimate future trip generation potential
- d. Determine the through trip percentages and E-E trips for the external station (external zone)
- e. Determine the I-E and E-I trips at each external station (external zone)



WALDPART, OREGON TRANSPORTATION SYSTEM PLAN UPDATE

- f. Determine the trip distribution for the I-E and E-I trips for each internal TAZ
 - g. Determine the trip distribution for I-I trips
 - h. Calculate network link travel times
 - i. Assign total trips to the network
5. *Signal Timing Data* will be requested from ODOT for use in the existing conditions analysis. Signal parameters such as Flash Don't Walk, Walk, and Minimum Times will be retained in the forecast analysis with the signal splits optimized to better serve the future traffic volume patterns. Optimized signal cycle lengths may range between 60 and 120 seconds.
6. Traffic Operations
- a. Study intersection traffic operations will be analyzed with Synchro 10 software using HCM 6th Edition. Where Synchro 10 is unable to apply HCM 6th Edition, HCM 2010 and HCM 2000 will be used as appropriate.
 - b. Queuing analysis methodology will be based on Synchro 95th percentile queue lengths. If any of the Synchro 95th percentile queue lengths exceed capacity (designated on the Synchro reports), a simulation-based queuing analysis (SimTraffic) will then be utilized.

TRAFFIC ANALYSIS SOFTWARE AND INPUT ASSUMPTIONS

Synchro 10 software will be used for the intersection analyses. The reported results will be the level of service, intersection delay, and v/c ratios generated by the HCM report. Analysis assumptions are listed in Table 5.

Table 5: Synchro Operations Parameters/Assumptions

Arterial Intersection Parameters	Existing Conditions
Peak Hour Factor	From traffic counts
Conflicting Bikes and Pedestrian per Hour	From traffic counts, as available
Area Type	Other
Ideal Saturation Flow Rate (for all movements)	1,750 passenger cars per hour green per lane
Lane Width	12 feet unless field observations suggest otherwise
Percent Heavy Vehicles	From traffic counts by movement, as available
Percent Grade	Estimated based on field observations
Parking Maneuvers per Hour	Estimated based on field observations
Bus Blockages	Estimated based on frequency of service
Intersection signal phasing and coordination	From ODOT/County/City
Intersection signal timing optimization limits	Maximum cycle length = 120 seconds



WALDPORT, OREGON TRANSPORTATION SYSTEM PLAN UPDATE

Arterial Intersection Parameters	Existing Conditions
Minimum Green time	From timing plans
Yellow and all-red time	From timing plans
95 th percentile vehicle queues	Synchro 10 summary output

MULTI-MODAL ANALYSIS

The multimodal analysis will be performed in accordance with the methodologies identified in Chapter 14 of the APM and identify the needs associated with pedestrian, bicycle, and public transportation facilities and service. The pedestrian and bicycle analyses will include a Pedestrian Level of Traffic Stress (PLTS) and a Bicycle Level of Traffic Stress (BLTS) analysis, consistent with the methodologies identified in the APM. All analysis results will be presented in a tabular format and as part of a GIS map. Both PLTS and BLTS methods group facilities into four different stress levels for segments, intersection approaches, and intersection crossings. Facilities with an LTS 1 rating have little to no traffic stress, require less attention, and are suitable for all users. Facilities with an LTS 2 rating have little traffic stress, but require more attention and therefore, may or may not be suitable for small children. Facilities with an LTS 3 rating have moderate traffic stress and are suitable for adults. Facilities with an LTS 4 rating have high traffic stress and are only suitable for able-bodied adults with limited options. The transit analysis will include a qualitative multi-modal assessment of service and identification of underserved areas based on guidance in the APM.

CRASH ANALYSIS

The five most recent years of *final and complete* crash data will be reviewed at the study intersections and along the City's roadway segments consistent with the methodologies outlined in the APM. The data will be analyzed for number, type, severity, and location to identify potential crash patterns and million entering vehicle (MEV) crash rates (critical crash rates will also be developed and evaluated as applicable). Intersection crash rates will be compared to the published 90th percentile crash rates in Exhibit 4.1 of the APM and segment crash rates will be compared to Table II in the current ODOT Crash Rate Tables. In addition, ODOT's top 10% ODOT Safety Priority System sites will be reviewed, as appropriate. Any identified potential countermeasures (and any resulting crash percentage reduction) will be taken from the All Roads Transportation Safety (ARTS) Crash Reduction Factors (CRF) listing or the CRF Appendix.

REFERENCES

1. Oregon Department of Transportation. *Transportation System Plan Guidelines*, 2018.
2. Oregon Department of Transportation. *Analysis Procedures Manual*, 2018.
3. Oregon Department of Transportation. *Oregon Highway Plan*, 2018.
4. Oregon Department of Transportation. *Highway Design Manual*, 2012.



ATTACHMENTS

A. Traffic Counts



WALDPART, OREGON TRANSPORTATION SYSTEM PLAN UPDATE

ATTACHMENT A TRAFFIC COUNTS

LOCATION: US 101 -- NW Spring St
CITY/STATE: Waldport, OR

QC JOB #: 14830101
DATE: Wed, Sep 12 2018

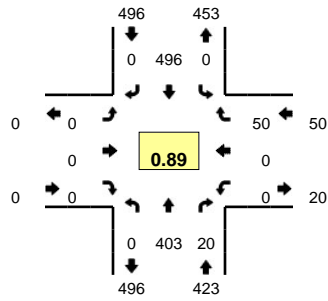

Peak-Hour: 4:15 PM -- 5:15 PM
Peak 15-Min: 4:15 PM -- 4:30 PM

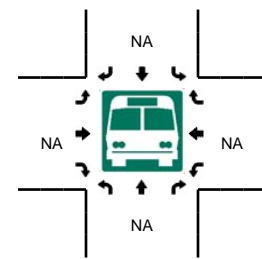
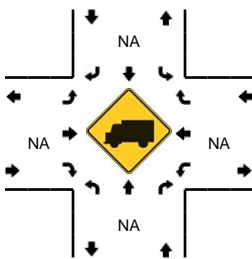
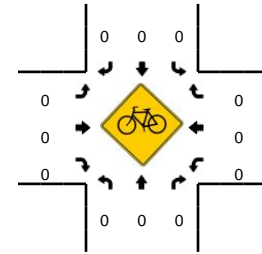
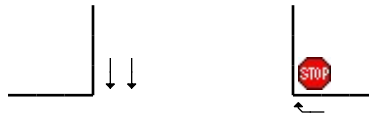
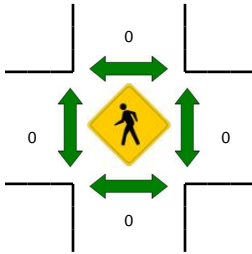
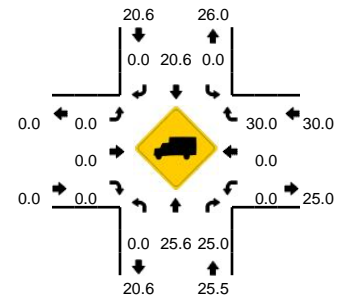

15-Min Count Period Beginning At	US 101 (Northbound)				US 101 (Southbound)				NW Spring St (Eastbound)				NW Spring St (Westbound)				Total	Hourly Totals	
	Left	Thru	Right	U	Left	Thru	Right	U	Left	Thru	Right	U	Left	Thru	Right	U			
2:00 PM	0	77	5	0	0	113	0	0	0	0	0	0	0	0	0	14	0	209	
2:15 PM	0	134	4	0	0	126	0	0	0	0	0	0	0	0	0	11	0	275	
2:30 PM	0	128	2	0	0	105	0	0	0	0	0	0	0	0	0	15	0	250	
2:45 PM	0	101	4	0	0	116	0	0	0	0	0	0	0	0	0	17	0	238	972
3:00 PM	0	102	3	0	0	131	0	0	0	0	0	0	0	0	0	19	0	255	1018
3:15 PM	0	85	5	0	0	143	0	0	0	0	0	0	0	0	0	9	0	242	985
3:30 PM	0	96	2	0	0	104	0	0	0	0	0	0	0	0	0	13	0	215	950
3:45 PM	0	103	3	0	0	128	0	0	0	0	0	0	0	0	0	10	0	244	956
4:00 PM	0	90	6	0	0	120	0	0	0	0	0	0	0	0	0	19	0	235	936
4:15 PM	0	124	5	0	0	130	0	0	0	0	0	0	0	0	0	12	0	271	965
4:30 PM	0	88	3	0	0	125	0	0	0	0	0	0	0	0	0	18	0	234	984
4:45 PM	0	93	4	0	0	123	0	0	0	0	0	0	0	0	0	8	0	228	968
5:00 PM	0	98	8	0	0	118	0	0	0	0	0	0	0	0	0	12	0	236	969
5:15 PM	0	77	1	0	0	126	0	0	0	0	0	0	0	0	0	7	0	211	909
5:30 PM	0	77	1	0	0	121	0	0	0	0	0	0	0	0	0	10	0	209	884
5:45 PM	0	80	4	0	0	103	0	0	0	0	0	0	0	0	0	8	0	195	851
Peak 15-Min Flowrates	Northbound				Southbound				Eastbound				Westbound				Total		
	Left	Thru	Right	U	Left	Thru	Right	U	Left	Thru	Right	U	Left	Thru	Right	U			
All Vehicles	0	496	20	0	0	520	0	0	0	0	0	0	0	0	48	0	1084		
Heavy Trucks	0	136	0		0	136	0		0	0	0		0	0	8		280		
Pedestrians		0				0				0				0				0	
Bicycles	0	0	0		0	0	0		0	0	0		0	0	0			0	
Railroad																		0	
Stopped Buses																		0	

Comments:

LOCATION: NW Cedar St -- OR 34/NW Hemlock St
CITY/STATE: Waldport, OR

QC JOB #: 14830102
DATE: Wed, Sep 12 2018

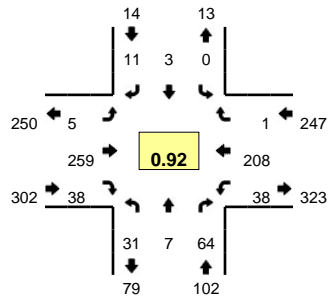

Peak-Hour: 4:15 PM -- 5:15 PM
Peak 15-Min: 4:30 PM -- 4:45 PM

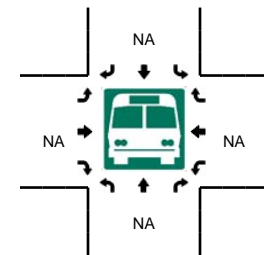
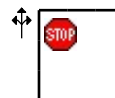
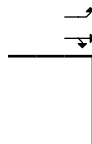
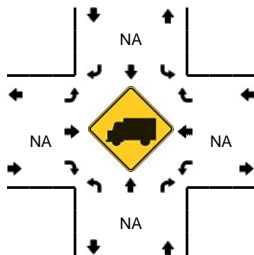
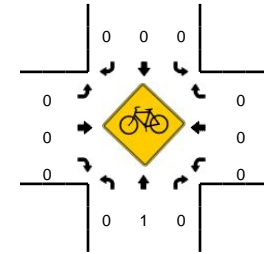
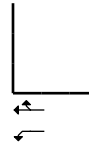
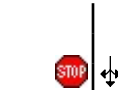
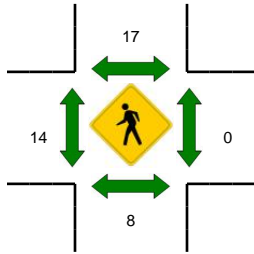
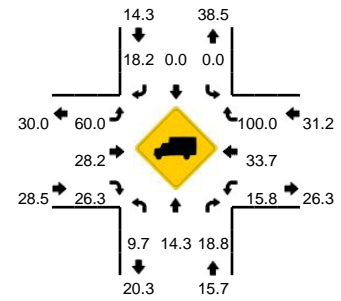

15-Min Count Period Beginning At	NW Cedar St (Northbound)				NW Cedar St (Southbound)				OR 34/NW Hemlock St (Eastbound)				OR 34/NW Hemlock St (Westbound)				Total	Hourly Totals
	Left	Thru	Right	U	Left	Thru	Right	U	Left	Thru	Right	U	Left	Thru	Right	U		
2:00 PM	4	3	21	0	1	1	11	0	4	74	11	0	13	58	2	0	203	
2:15 PM	15	5	17	0	1	2	6	0	1	73	15	0	12	82	1	0	230	
2:30 PM	16	2	16	0	0	2	2	0	1	61	6	0	6	69	1	0	182	
2:45 PM	7	3	18	0	0	1	3	0	3	52	6	0	4	60	0	0	157	772
3:00 PM	11	2	12	0	0	0	3	0	0	64	9	0	10	57	2	0	170	739
3:15 PM	8	1	16	0	1	4	2	0	2	72	14	0	13	62	2	0	197	706
3:30 PM	10	2	9	0	0	1	1	0	1	68	9	0	8	48	1	0	158	682
3:45 PM	6	4	23	0	0	1	1	0	1	54	10	0	10	50	0	0	160	685
4:00 PM	11	2	17	0	1	0	0	0	2	54	10	0	8	51	0	0	156	671
4:15 PM	8	2	17	0	0	0	4	0	1	61	14	0	7	44	0	0	158	632
4:30 PM	9	4	13	0	0	1	5	0	2	68	8	0	15	54	1	0	180	654
4:45 PM	8	1	17	0	0	2	0	0	1	69	10	0	10	55	0	0	173	667
5:00 PM	6	0	17	0	0	0	2	0	1	61	6	0	6	55	0	0	154	665
5:15 PM	6	5	2	0	0	0	1	0	1	85	10	0	7	49	0	0	166	673
5:30 PM	13	2	17	0	0	1	2	0	0	60	5	0	9	43	0	0	152	645
5:45 PM	10	3	8	0	0	2	1	0	1	44	11	0	10	39	0	0	129	601
Peak 15-Min Flowrates	Northbound				Southbound				Eastbound				Westbound				Total	
	Left	Thru	Right	U	Left	Thru	Right	U	Left	Thru	Right	U	Left	Thru	Right	U		
All Vehicles	36	16	52	0	0	4	20	0	8	272	32	0	60	216	4	0	720	
Heavy Trucks	4	4	16		0	0	4		4	100	12		16	84	4		248	
Pedestrians		8				16				12				0			36	
Bicycles	0	0	0		0	0	0		0	0	0		0	0	0		0	
Railroad																		
Stopped Buses																		

Comments:

LOCATION: SW Cedar St -- S Crestline Dr
CITY/STATE: Waldport, OR

QC JOB #: 14830103
DATE: Wed, Sep 12 2018

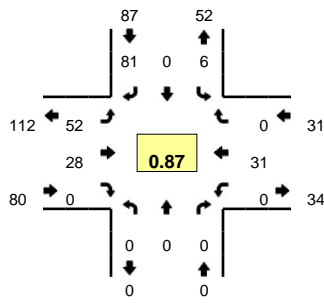

Peak-Hour: 4:15 PM -- 5:15 PM
Peak 15-Min: 4:45 PM -- 5:00 PM

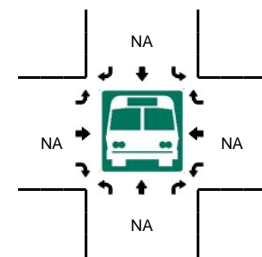
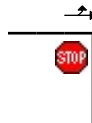
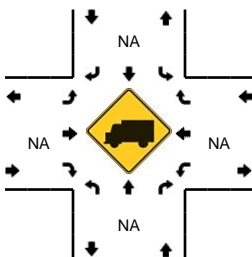
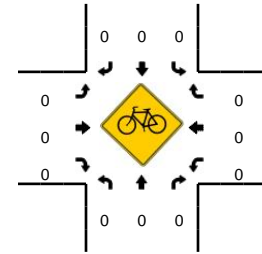
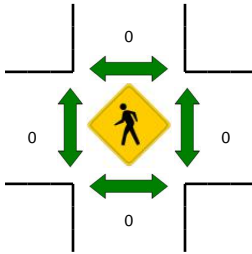
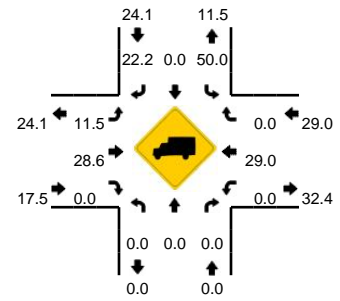

15-Min Count Period Beginning At	SW Cedar St (Northbound)				SW Cedar St (Southbound)				S Crestline Dr (Eastbound)				S Crestline Dr (Westbound)				Total	Hourly Totals
	Left	Thru	Right	U	Left	Thru	Right	U	Left	Thru	Right	U	Left	Thru	Right	U		
2:00 PM	0	0	0	0	0	0	22	0	17	17	0	0	0	6	0	0	62	
2:15 PM	0	0	0	0	2	0	16	0	23	13	0	0	0	8	1	0	63	
2:30 PM	0	0	0	0	0	0	10	0	28	5	0	0	0	8	2	0	53	
2:45 PM	0	0	0	0	2	0	11	0	13	9	0	0	0	8	0	0	43	221
3:00 PM	0	0	0	0	0	0	14	0	14	8	0	0	0	5	1	0	42	201
3:15 PM	0	0	0	0	0	0	22	0	11	5	0	0	0	11	0	0	49	187
3:30 PM	0	0	0	0	2	0	13	0	12	10	0	0	0	9	1	0	47	181
3:45 PM	0	0	0	0	0	0	17	0	14	10	0	0	0	12	2	0	55	193
4:00 PM	0	0	0	0	2	0	19	0	22	9	0	0	0	7	1	0	60	211
4:15 PM	0	0	0	0	2	0	21	0	18	7	0	0	0	3	0	0	51	213
4:30 PM	0	0	0	0	2	0	20	0	19	7	0	0	0	4	0	0	52	218
4:45 PM	0	0	0	0	2	0	25	0	8	7	0	0	0	15	0	0	57	220
5:00 PM	0	0	0	0	0	0	15	0	7	7	0	0	0	9	0	0	38	198
5:15 PM	0	0	0	0	2	0	23	0	9	12	0	0	0	8	0	0	54	201
5:30 PM	0	0	0	0	0	0	17	0	10	4	0	0	0	4	0	0	35	184
5:45 PM	0	0	0	0	0	0	17	0	16	9	0	0	0	11	0	0	53	180
Peak 15-Min Flowrates	Northbound				Southbound				Eastbound				Westbound				Total	
	Left	Thru	Right	U	Left	Thru	Right	U	Left	Thru	Right	U	Left	Thru	Right	U		
All Vehicles	0	0	0	0	8	0	100	0	32	28	0	0	0	60	0	0	228	
Heavy Trucks	0	0	0	0	4	0	8	0	0	20	0	0	0	16	0	0	48	
Pedestrians		0				0				0				0			0	
Bicycles	0	0	0		0	0	0		0	0	0		0	0	0		0	
Railroad																		
Stopped Buses																		

Comments:

LOCATION: S Crestline Dr -- SW Range Dr
CITY/STATE: Waldport, OR

QC JOB #: 14830104
DATE: Wed, Sep 12 2018

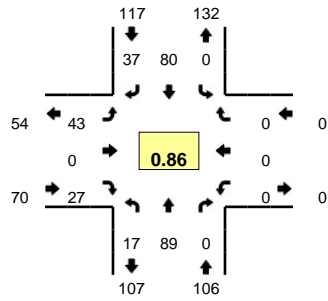

Peak-Hour: 4:15 PM -- 5:15 PM
Peak 15-Min: 5:00 PM -- 5:15 PM

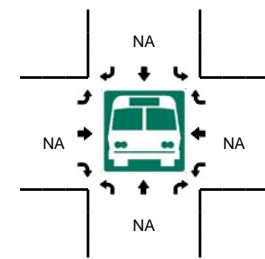
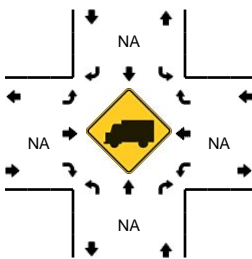
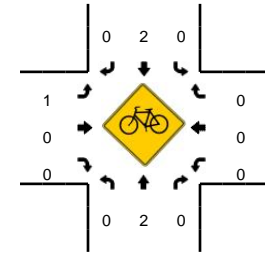
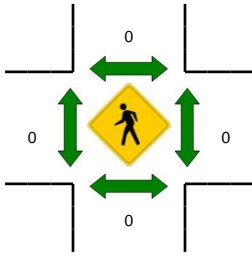
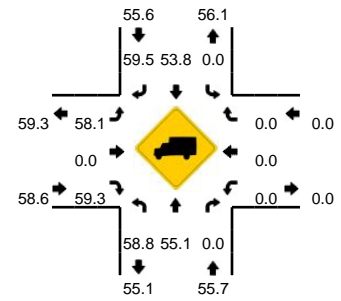

15-Min Count Period Beginning At	S Crestline Dr (Northbound)				S Crestline Dr (Southbound)				SW Range Dr (Eastbound)				SW Range Dr (Westbound)				Total	Hourly Totals
	Left	Thru	Right	U	Left	Thru	Right	U	Left	Thru	Right	U	Left	Thru	Right	U		
2:00 PM	30	52	0	0	0	16	3	0	8	0	14	0	0	0	0	0	123	
2:15 PM	22	65	0	0	0	28	11	0	10	0	27	0	0	0	0	0	163	
2:30 PM	14	43	0	0	0	15	13	0	9	0	8	0	0	0	0	0	102	
2:45 PM	4	15	0	0	0	18	17	0	8	0	9	0	0	0	0	0	71	459
3:00 PM	5	15	0	0	0	7	10	0	13	0	11	0	0	0	0	0	61	397
3:15 PM	11	23	0	0	0	39	8	0	4	0	18	0	0	0	0	0	103	337
3:30 PM	11	30	0	0	0	31	5	0	4	0	22	0	0	0	0	0	103	338
3:45 PM	6	32	0	0	0	31	10	0	7	0	5	0	0	0	0	0	91	358
4:00 PM	17	43	0	0	0	23	11	0	10	0	4	0	0	0	0	0	108	405
4:15 PM	7	24	0	0	0	12	6	0	13	0	9	0	0	0	0	0	71	373
4:30 PM	2	27	0	0	0	18	4	0	4	0	6	0	0	0	0	0	61	331
4:45 PM	2	17	0	0	0	28	16	0	10	0	3	0	0	0	0	0	76	316
5:00 PM	6	21	0	0	0	22	11	0	16	0	9	0	0	0	0	0	85	293
5:15 PM	7	16	0	0	0	26	12	0	11	0	2	0	0	0	0	0	74	296
5:30 PM	6	17	0	0	0	14	12	0	4	0	6	0	0	0	0	0	59	294
5:45 PM	7	44	0	0	0	23	11	0	4	0	12	0	0	0	0	0	101	319
Peak 15-Min Flowrates	Northbound				Southbound				Eastbound				Westbound				Total	
	Left	Thru	Right	U	Left	Thru	Right	U	Left	Thru	Right	U	Left	Thru	Right	U		
All Vehicles	24	84	0	0	0	88	44	0	64	0	36	0	0	0	0	0	340	
Heavy Trucks	12	48	0	0	0	48	24	0	36	0	24	0	0	0	0	0	192	
Pedestrians	0	0	0	0	0	0	0	0	0	0	0	0	0	0	0	0	0	
Bicycles	0	0	0	0	0	1	0	0	1	0	0	0	0	0	0	0	2	
Railroad																		
Stopped Buses																		

Comments:

LOCATION: NE Crestline Dr -- OR 34
CITY/STATE: Waldport, OR

QC JOB #: 14830105
DATE: Wed, Sep 12 2018

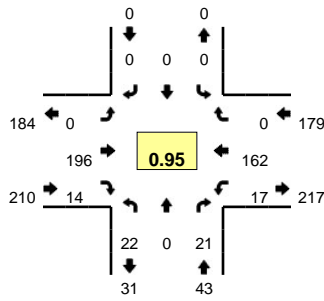

Peak-Hour: 4:15 PM -- 5:15 PM
Peak 15-Min: 4:45 PM -- 5:00 PM

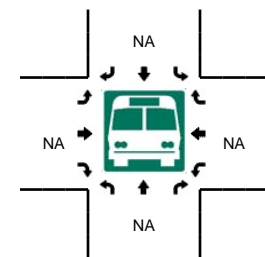
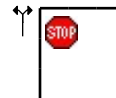
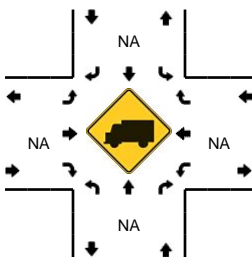
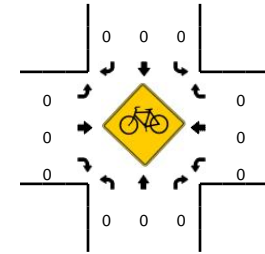
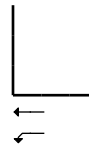
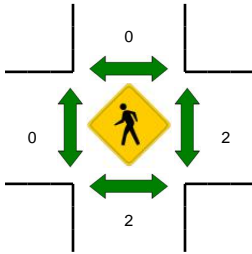
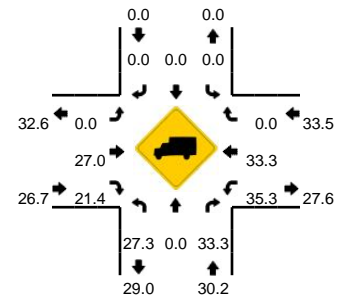

15-Min Count Period Beginning At	NE Crestline Dr (Northbound)				NE Crestline Dr (Southbound)				OR 34 (Eastbound)				OR 34 (Westbound)				Total	Hourly Totals
	Left	Thru	Right	U	Left	Thru	Right	U	Left	Thru	Right	U	Left	Thru	Right	U		
2:00 PM	7	0	8	0	0	0	0	0	0	46	3	0	2	49	0	0	115	
2:15 PM	12	0	8	0	0	0	0	0	0	47	4	0	5	57	0	0	133	
2:30 PM	2	0	7	0	0	0	0	0	0	53	1	0	7	45	0	0	115	
2:45 PM	5	0	2	0	0	0	0	0	0	50	3	0	6	51	0	0	117	480
3:00 PM	5	0	5	0	0	0	0	0	0	45	3	0	2	48	0	0	108	473
3:15 PM	5	0	3	0	0	0	0	0	0	54	3	0	5	47	0	0	117	457
3:30 PM	2	0	6	0	0	0	0	0	0	44	6	0	5	44	0	0	107	449
3:45 PM	11	0	3	0	0	0	0	0	0	58	2	0	8	43	0	0	125	457
4:00 PM	5	0	9	0	0	0	0	0	0	42	5	0	5	45	0	0	111	460
4:15 PM	6	0	5	0	0	0	0	0	0	52	1	0	1	41	0	0	106	449
4:30 PM	4	0	6	0	0	0	0	0	0	41	2	0	2	43	0	0	98	440
4:45 PM	6	0	6	0	0	0	0	0	0	53	6	0	9	34	0	0	114	429
5:00 PM	6	0	4	0	0	0	0	0	0	50	5	0	5	44	0	0	114	432
5:15 PM	10	0	3	0	0	0	0	0	0	55	0	0	8	43	0	0	119	445
5:30 PM	4	0	6	0	0	0	0	0	0	56	0	0	4	38	0	0	108	455
5:45 PM	5	0	4	0	0	0	0	0	0	34	3	0	5	42	0	0	93	434
Peak 15-Min Flowrates	Northbound				Southbound				Eastbound				Westbound				Total	
	Left	Thru	Right	U	Left	Thru	Right	U	Left	Thru	Right	U	Left	Thru	Right	U		
All Vehicles	24	0	24	0	0	0	0	0	0	212	24	0	36	136	0	0	456	
Heavy Trucks	12	0	8	0	0	0	0	0	0	36	4	0	12	40	0	0	112	
Pedestrians		8				0				0				8			16	
Bicycles	0	0	0		0	0	0		0	0	0		0	0	0		0	
Railroad																		
Stopped Buses																		

Comments:

LOCATION: US 101 -- SW Range Dr
CITY/STATE: Waldport, OR

QC JOB #: 14830106
DATE: Wed, Sep 12 2018

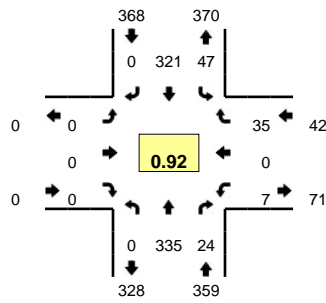

Peak-Hour: 4:15 PM -- 5:15 PM
Peak 15-Min: 4:15 PM -- 4:30 PM

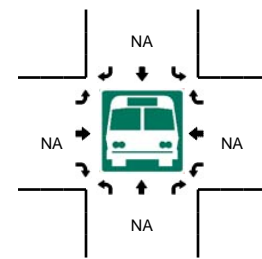
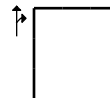
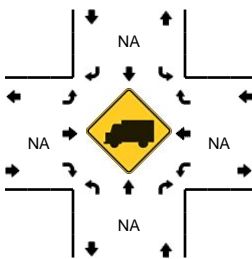
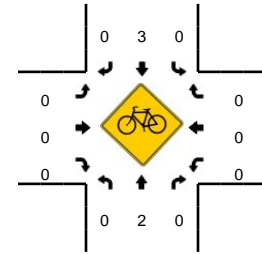
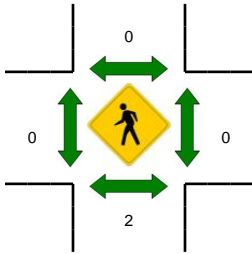
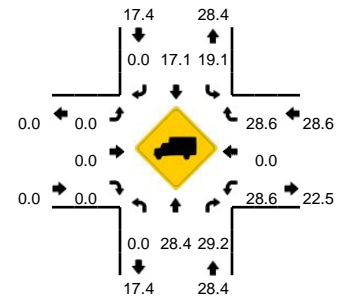

15-Min Count Period Beginning At	US 101 (Northbound)				US 101 (Southbound)				SW Range Dr (Eastbound)				SW Range Dr (Westbound)				Total	Hourly Totals
	Left	Thru	Right	U	Left	Thru	Right	U	Left	Thru	Right	U	Left	Thru	Right	U		
2:00 PM	0	67	10	0	16	96	0	0	0	0	0	0	4	0	16	0	209	
2:15 PM	0	109	6	0	17	90	0	0	0	0	0	0	4	0	15	0	241	
2:30 PM	0	95	5	0	12	88	0	0	0	0	0	0	4	0	11	0	215	
2:45 PM	0	85	6	0	14	88	0	0	0	0	0	0	3	0	17	0	213	878
3:00 PM	0	76	2	0	15	113	0	0	0	0	0	0	3	0	10	0	219	888
3:15 PM	0	84	5	0	7	106	0	0	0	0	0	0	7	0	11	0	220	867
3:30 PM	0	99	5	0	22	84	0	0	0	0	0	0	0	0	8	0	218	870
3:45 PM	0	81	2	0	9	78	0	0	0	0	0	0	5	0	14	0	189	846
4:00 PM	0	75	4	0	6	90	0	0	0	0	0	0	3	0	16	0	194	821
4:15 PM	0	107	5	0	13	78	0	0	0	0	0	0	1	0	6	0	210	811
4:30 PM	0	73	5	0	13	78	0	0	0	0	0	0	1	0	9	0	179	772
4:45 PM	0	78	6	0	5	80	0	0	0	0	0	0	2	0	8	0	179	762
5:00 PM	0	77	8	0	16	85	0	0	0	0	0	0	3	0	12	0	201	769
5:15 PM	0	81	3	0	19	75	0	0	0	0	0	0	3	0	4	0	185	744
5:30 PM	0	55	3	0	12	69	0	0	0	0	0	0	7	0	8	0	154	719
5:45 PM	0	57	4	0	18	61	0	0	0	0	0	0	3	0	8	0	151	691
Peak 15-Min Flowrates	Northbound				Southbound				Eastbound				Westbound				Total	
	Left	Thru	Right	U	Left	Thru	Right	U	Left	Thru	Right	U	Left	Thru	Right	U		
All Vehicles	0	428	20	0	52	312	0	0	0	0	0	0	4	0	24	0	840	
Heavy Trucks	0	136	8		12	72	0		0	0	0		0	0	12		240	
Pedestrians		0				0				0				0				0
Bicycles	0	1	0		0	2	0		0	0	0		0	0	0		3	
Railroad																		
Stopped Buses																		

Comments:

LOCATION: US 101 -- OR 34
CITY/STATE: Waldport, OR

QC JOB #: 14830107
DATE: Mon, Oct 08 2018

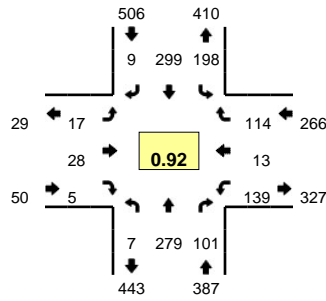

Peak-Hour: 4:15 PM -- 5:15 PM
Peak 15-Min: 4:15 PM -- 4:30 PM

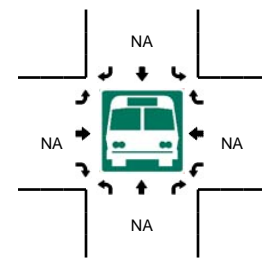
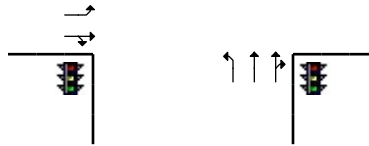
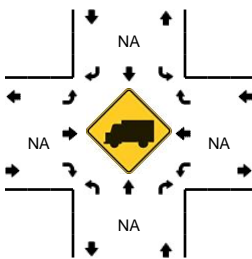
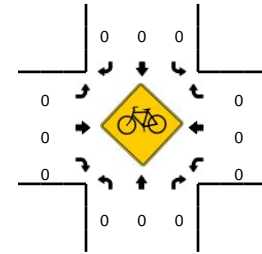
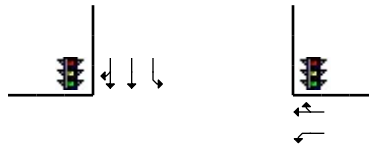
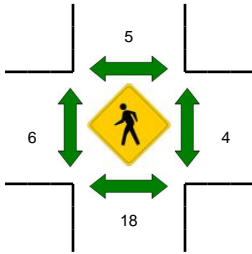
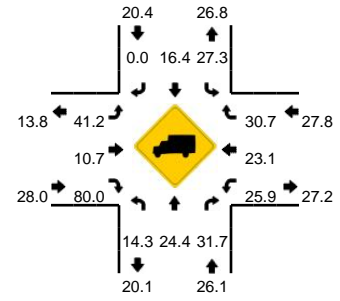

15-Min Count Period Beginning At	US 101 (Northbound)				US 101 (Southbound)				OR 34 (Eastbound)				OR 34 (Westbound)				Total	Hourly Totals
	Left	Thru	Right	U	Left	Thru	Right	U	Left	Thru	Right	U	Left	Thru	Right	U		
1:45 PM	1	61	35	0	43	73	2	0	3	9	0	0	45	5	24	0	301	1261
2:00 PM	2	50	31	0	49	65	2	0	5	11	4	0	46	7	26	0	298	1225
2:15 PM	0	80	37	0	41	77	1	0	11	11	1	0	44	8	36	0	347	1282
2:30 PM	3	82	29	0	30	78	3	0	3	7	1	0	40	5	46	0	327	1273
2:45 PM	1	72	24	0	43	72	3	0	7	1	2	0	50	7	22	0	304	1276
3:00 PM	3	64	25	0	43	82	4	0	9	8	2	0	34	6	30	0	310	1288
3:15 PM	1	55	34	0	44	84	3	0	9	4	0	0	44	3	21	0	302	1243
3:30 PM	1	63	37	0	42	90	4	0	6	7	0	0	29	5	28	0	312	1228
3:45 PM	2	80	18	0	50	73	3	0	6	2	4	0	39	4	25	0	306	1230
4:00 PM	3	70	19	0	43	67	5	0	3	6	5	0	29	3	24	0	277	1197
4:15 PM	1	87	24	0	56	80	3	0	8	7	1	0	28	4	31	0	330	1225
4:30 PM	1	61	25	0	51	75	2	0	4	6	1	0	39	4	21	0	290	1203
4:45 PM	3	56	23	0	56	69	1	0	1	6	1	0	28	2	40	0	286	1183
5:00 PM	2	75	29	0	35	75	3	0	4	9	2	0	44	3	22	0	303	1209
5:15 PM	1	55	30	0	56	75	3	0	4	11	2	0	30	7	21	0	295	1174
5:30 PM	1	49	19	0	42	73	2	0	4	12	0	0	20	6	28	0	256	1140
5:45 PM	1	55	15	0	40	58	3	0	5	6	1	0	31	3	22	0	240	1094
6:00 PM	0	40	28	0	46	49	0	0	3	3	1	0	31	2	28	0	231	1022
6:15 PM	1	40	25	0	43	58	2	0	0	1	1	0	24	0	16	0	211	938
6:30 PM	1	27	16	0	36	39	1	0	4	1	0	0	15	3	12	0	155	837
6:45 PM	1	31	25	0	29	41	0	0	3	1	1	0	24	2	16	0	174	771
7:00 PM	0	26	14	0	22	25	1	0	3	0	0	0	21	3	9	0	124	664
7:15 PM	1	15	10	0	30	35	0	0	1	3	2	0	13	1	12	0	123	576
7:30 PM	0	23	7	0	22	17	0	0	2	1	1	0	15	1	10	0	99	520
Peak 15-Min Flowrates	Northbound				Southbound				Eastbound				Westbound				Total	
	Left	Thru	Right	U	Left	Thru	Right	U	Left	Thru	Right	U	Left	Thru	Right	U		
All Vehicles	4	348	96	0	224	320	12	0	32	28	4	0	112	16	124	0	1320	
Heavy Trucks	0	84	24		64	64	0		20	4	4		40	8	40		352	
Pedestrians		32			0					16			4				52	
Bicycles	0	0	0		0	0	0		0	0	0		0	0	0		0	
Railroad																		
Stopped Buses																		

Comments:

LOCATION: NE Mill St -- OR 34
CITY/STATE: Waldport, OR

QC JOB #: 14830108
DATE: Wed, Sep 12 2018

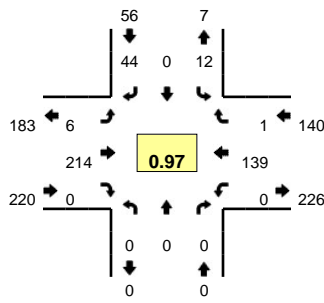

Peak-Hour: 4:15 PM -- 5:15 PM
Peak 15-Min: 4:45 PM -- 5:00 PM

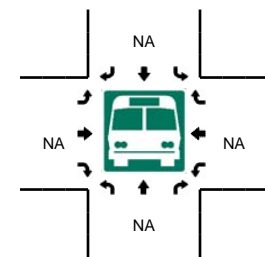
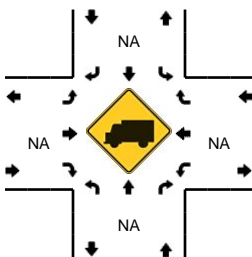
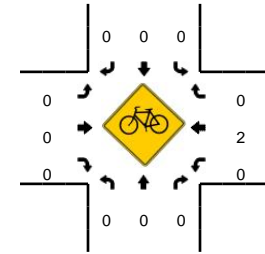
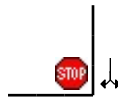
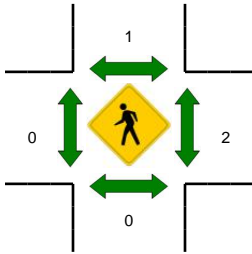
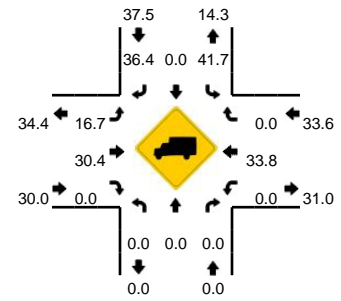

15-Min Count Period Beginning At	NE Mill St (Northbound)				NE Mill St (Southbound)				OR 34 (Eastbound)				OR 34 (Westbound)				Total	Hourly Totals
	Left	Thru	Right	U	Left	Thru	Right	U	Left	Thru	Right	U	Left	Thru	Right	U		
2:00 PM	0	0	0	0	3	0	9	0	0	53	0	0	0	42	2	0	109	
2:15 PM	0	0	0	0	2	0	10	0	1	54	0	0	0	53	1	0	121	
2:30 PM	0	0	0	0	5	0	16	0	1	63	0	0	0	37	4	0	126	
2:45 PM	0	0	0	0	0	0	6	0	0	52	0	0	0	48	1	0	107	463
3:00 PM	0	0	0	0	2	0	10	0	2	48	0	0	0	41	1	0	104	458
3:15 PM	0	0	0	0	1	0	10	0	1	55	0	0	0	43	2	0	112	449
3:30 PM	0	0	0	0	3	0	7	0	1	51	0	0	0	41	2	0	105	428
3:45 PM	0	0	0	0	3	0	4	0	0	58	0	0	0	46	3	0	114	435
4:00 PM	0	0	0	0	3	0	11	0	2	48	0	0	0	37	0	0	101	432
4:15 PM	0	0	0	0	1	0	13	0	1	56	0	0	0	32	0	0	103	423
4:30 PM	0	0	0	0	3	0	11	0	1	49	0	0	0	36	0	0	100	418
4:45 PM	0	0	0	0	3	0	8	0	1	59	0	0	0	36	0	0	107	411
5:00 PM	0	0	0	0	5	0	12	0	3	50	0	0	0	35	1	0	106	416
5:15 PM	0	0	0	0	1	0	7	0	0	53	0	0	0	43	2	0	106	419
5:30 PM	0	0	0	0	1	0	8	0	1	66	0	0	0	36	2	0	114	433
5:45 PM	0	0	0	0	1	0	12	0	0	39	0	0	0	36	3	0	91	417
Peak 15-Min Flowrates	Northbound				Southbound				Eastbound				Westbound				Total	
	Left	Thru	Right	U	Left	Thru	Right	U	Left	Thru	Right	U	Left	Thru	Right	U		
All Vehicles	0	0	0	0	12	0	32	0	4	236	0	0	0	144	0	0	428	
Heavy Trucks	0	0	0	0	12	0	4	0	0	52	0	0	0	52	0	0	120	
Pedestrians		0				0				0				8			8	
Bicycles	0	0	0		0	0	0		0	0	0		0	0	0		0	
Railroad																		
Stopped Buses																		

Comments:

LOCATION: US 101 -- SW Starr St/Norwood Dr
CITY/STATE: Waldport, OR

QC JOB #: 14830109
DATE: Wed, Sep 12 2018

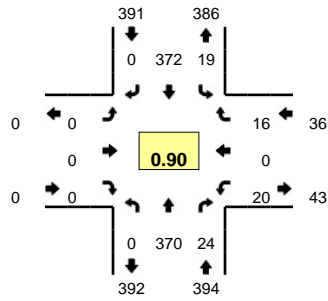

Peak-Hour: 4:15 PM -- 5:15 PM
Peak 15-Min: 4:15 PM -- 4:30 PM

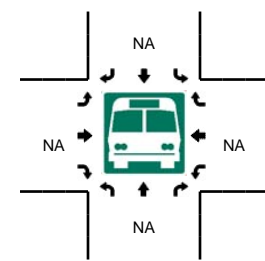
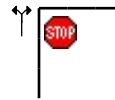
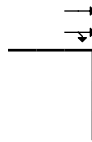
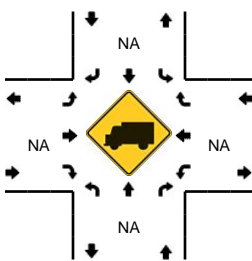
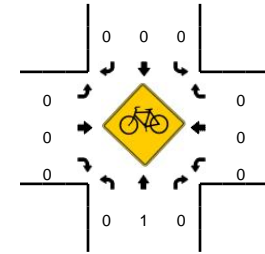
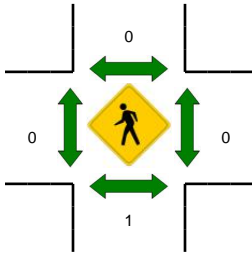
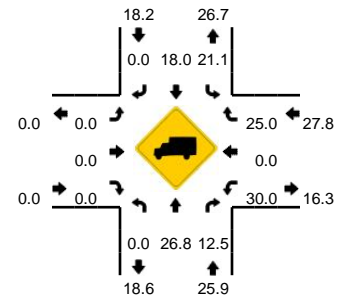

15-Min Count Period Beginning At	US 101 (Northbound)				US 101 (Southbound)				SW Starr St/Norwood Dr (Eastbound)				SW Starr St/Norwood Dr (Westbound)				Total	Hourly Totals
	Left	Thru	Right	U	Left	Thru	Right	U	Left	Thru	Right	U	Left	Thru	Right	U		
2:00 PM	0	82	7	0	6	106	0	0	0	0	0	0	6	0	7	0	214	
2:15 PM	0	116	8	0	4	116	0	0	0	0	0	0	1	0	6	0	251	
2:30 PM	0	108	5	0	6	110	0	0	0	0	0	0	6	0	7	0	242	
2:45 PM	0	102	7	0	3	111	0	0	0	0	0	0	5	0	5	0	233	940
3:00 PM	0	85	5	0	1	113	0	0	0	0	0	0	8	0	11	0	223	949
3:15 PM	0	85	6	0	4	121	0	0	0	0	0	0	5	0	4	0	225	923
3:30 PM	0	96	8	0	4	104	0	0	0	0	0	0	4	0	5	0	221	902
3:45 PM	0	95	6	0	8	100	0	0	0	0	0	0	2	0	7	0	218	887
4:00 PM	0	89	5	0	5	89	0	0	0	0	0	0	9	0	8	0	205	869
4:15 PM	0	110	7	0	7	96	0	0	0	0	0	0	3	0	4	0	227	871
4:30 PM	0	71	2	0	7	92	0	0	0	0	0	0	5	0	2	0	179	829
4:45 PM	0	94	7	0	1	84	0	0	0	0	0	0	4	0	5	0	195	806
5:00 PM	0	95	8	0	4	100	0	0	0	0	0	0	8	0	5	0	220	821
5:15 PM	0	80	2	0	7	91	0	0	0	0	0	0	4	0	7	0	191	785
5:30 PM	0	56	7	0	4	79	0	0	0	0	0	0	6	0	6	0	158	764
5:45 PM	0	60	2	0	4	82	0	0	0	0	0	0	4	0	8	0	160	729
Peak 15-Min Flowrates	Northbound				Southbound				Eastbound				Westbound				Total	
	Left	Thru	Right	U	Left	Thru	Right	U	Left	Thru	Right	U	Left	Thru	Right	U		
All Vehicles	0	440	28	0	28	384	0	0	0	0	0	0	12	0	16	0	908	
Heavy Trucks	0	136	4		4	96	0		0	0	0		0	0	4		244	
Pedestrians		0				0				0				0			0	
Bicycles	0	1	0		0	0	0		0	0	0		0	0	0		1	
Railroad																		
Stopped Buses																		

Comments: