

LOCATION: Grand Ave -- Elwood Ave
CITY/STATE: Oakland, CA

QC JOB #: 13350916
DATE: Thu, Apr 23 2015

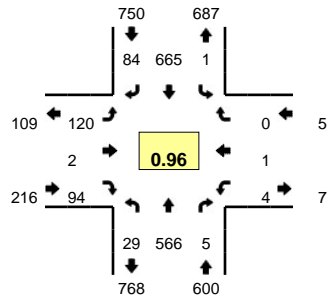

Peak-Hour: 4:50 PM -- 5:50 PM
Peak 15-Min: 5:35 PM -- 5:50 PM

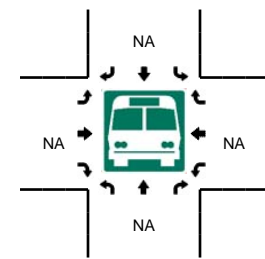
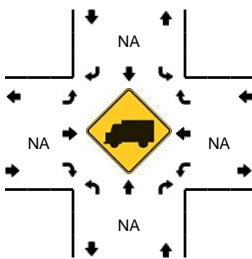
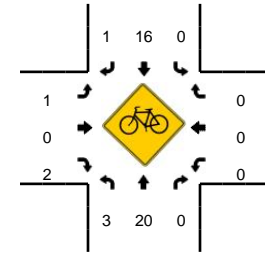
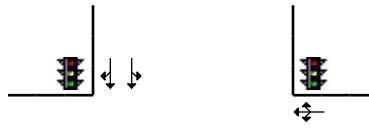
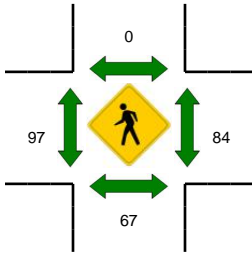
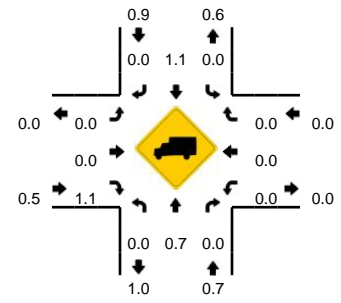

5-Min Count Period Beginning At	Grand Ave (Northbound)				Grand Ave (Southbound)				Elwood Ave (Eastbound)				Elwood Ave (Westbound)				Total	Hourly Totals	
	Left	Thru	Right	U	Left	Thru	Right	U	Left	Thru	Right	U	Left	Thru	Right	U			
4:00 PM	1	49	0	1	0	37	7	0	9	0	5	0	2	0	0	0	111		
4:05 PM	2	38	1	0	0	49	5	0	7	0	6	0	1	0	0	0	109		
4:10 PM	2	31	0	2	0	53	2	0	6	0	4	0	0	0	0	0	100		
4:15 PM	3	37	0	2	0	36	7	0	10	0	6	0	0	1	0	0	102		
4:20 PM	1	42	1	0	0	47	3	0	7	0	7	0	0	0	0	0	108		
4:25 PM	0	41	1	1	0	53	9	0	9	0	13	0	0	0	0	0	127		
4:30 PM	3	40	0	0	1	42	1	0	7	0	7	0	1	0	0	0	102		
4:35 PM	4	38	0	0	0	40	6	0	13	0	4	0	1	0	0	0	106		
4:40 PM	3	49	0	0	0	42	6	0	10	0	5	0	0	0	1	0	116		
4:45 PM	2	51	1	1	0	40	4	0	9	0	6	0	0	0	0	0	114		
4:50 PM	4	56	0	0	0	66	9	0	4	0	8	0	1	0	0	0	148		
4:55 PM	2	44	1	1	0	54	9	0	17	0	5	0	0	0	0	0	133	1376	
5:00 PM	1	35	0	0	0	50	7	0	13	0	12	0	0	0	0	0	118	1383	
5:05 PM	5	45	1	1	0	72	7	0	6	0	9	0	0	0	0	0	146	1420	
5:10 PM	2	45	0	0	0	52	8	0	11	1	7	0	1	1	0	0	128	1448	
5:15 PM	0	46	1	1	0	55	6	0	13	0	7	0	1	0	0	0	130	1476	
5:20 PM	0	46	0	1	0	49	3	0	9	0	7	0	0	0	0	0	115	1483	
5:25 PM	2	51	0	0	0	53	6	0	9	0	7	0	0	0	0	0	128	1484	
5:30 PM	2	50	1	0	0	51	5	0	1	0	7	0	0	0	0	0	117	1499	
5:35 PM	2	49	0	0	0	52	5	0	11	1	13	0	1	0	0	0	134	1527	
5:40 PM	1	50	0	1	0	55	9	1	9	0	7	0	0	0	0	0	133	1544	
5:45 PM	3	49	1	0	0	56	10	0	17	0	5	0	0	0	0	0	141	1571	
5:50 PM	4	41	0	1	0	49	9	1	16	0	7	0	0	1	0	0	129	1552	
5:55 PM	3	66	0	1	0	52	10	0	11	0	6	0	0	0	0	0	149	1568	
Peak 15-Min Flowrates	Northbound				Southbound				Eastbound				Westbound				Total		
	Left	Thru	Right	U	Left	Thru	Right	U	Left	Thru	Right	U	Left	Thru	Right	U			
All Vehicles	24	592	4	4	0	652	96	4	148	4	100	0	4	0	0	0	1632		
Heavy Trucks	0	4	0	0	0	4	0	0	0	0	0	0	0	0	0	0	8		
Pedestrians		96				0				72				84			252		
Bicycles	0	5	0	0	0	6	0	0	0	0	1	0	0	0	0	0	12		
Railroad																			
Stopped Buses																			

Comments: